



SENTRY



WK2



WK3



WK4



WK5

PHYSICAL WATER CONDITIONER TO TREAT HARD WATER

Introduction

Water-King is an electronic Physical Water Conditioner that inhibits scale formation in hot and cold water services, removes existing scale deposits and partially softens hot water. It requires no plumbing and there is no need for ongoing maintenance or servicing.

The technology explained

Water-King uses pre-programmed micro-chips to transmit pulses of electrical charge into the water at varying frequencies and amplitudes. These "signals" cause some of the minerals in the water to form sub-microscopic clusters. When the water is then heated, the clusters act as nucleation seeds upon which the calcium carbonate (limescale) precipitates. Instead of the hard encrustation on pipes and heating elements that normally occurs when water is heated, the precipitation takes the form of tiny calcium carbonate crystals that float suspended in the water. These ultra-fine crystals are carried away with the flowing water.

Applications

Field trials conducted over the past fifteen years around the world have demonstrated the effectiveness of Water-King in most applications where conventional water softeners would normally be used. Water-King is less expensive to install and maintain than ion exchange softeners. In larger applications it is also less expensive and simpler to install than inline magnetic and electro magnetic systems. Water-King requires very little space, no special plumbing, no waste water connection nor access for the supply of salt and its storage. There is no head loss nor any additional corrosion problems.

How Is The Water Softened Without Removing The Calcium?

The nucleation seeds created by Water-King stimulate the conversion of more of the dissolved calcium bicarbonate in the water into crystals in suspension than would otherwise occur. The resulting hot water, with less calcium bicarbonate, is now chemically softer. Water-King is the only electronic device of its kind that has been proven by independent laboratory tests to produce softer hot water.

Drinking Water and Salinity

Unlike ion exchange softened water, where minerals are removed and replaced by sodium, Water-King treated water is good for drinking. There is no need for a separate drinking water supply, no health risks and no chloride effluent. It can be used for reducing scale in irrigation systems and food preparation facilities.

Removal of Existing Scale Deposits

Water-King is very effective at removing existing scale deposits from water heaters. Descaling occurs within a few weeks. The scale breaks away in flakes as it loses adhesion with the surface that it is encrusting. In existing systems that are already badly scaled it may be worth installing a filter on the hot flow from the water heaters to protect mixing valves and other appliances from scale that has broken away.

Lifecycle Costs

Running costs of all units is less than £15.00 per annum. The design life is in excess of 25 years with a 5-year manufacturer's warranty. Water-King comes with a no quibble 100-day money-back satisfaction guarantee. This is extendable subject to negotiation.

Part L Regulations & BREEAM

Installing a Water-King unit ensures compliance with the Domestic Heating Compliance Guide included in the Part L Regulations - water treatment is required to reduce the accumulation of limescale in domestic water heaters. Water-King units have been awarded BREEAM credits on building projects. For more information please call our technical hotline.

Location of Units

Location

In general a Water-King unit should be installed as close as possible to the appliance where water is to be heated and scale is likely to form. This means in practice it should be installed on the cold service within the same plant room as the calorifier or water heater. If point-of-use electric water heaters are being used where hot water draw-off is sparse or spasmodic, such as in an office environment, it is best to fit a dedicated unit such as the Sentry to each heater or cluster of heaters.

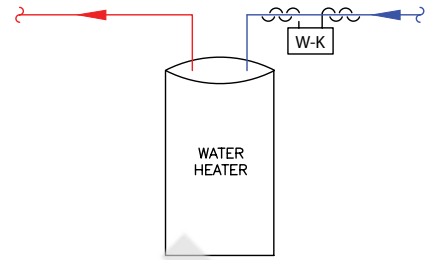

Signal Propagation

The signal generated by Water-King is transmitted through the water both upstream (back signal) and downstream from the unit. This means that appliances and storage tanks upstream from the unit can be treated.

Cold Water Storage Cisterns and Break Tanks

Vented cold water storage cisterns generally cause a discontinuity in the signal transmission resulting in decay of the clustering effect generated by the Water-King. This problem can be overcome by installing a unit on one of the outlet pipes from the cistern or header and utilising the "Back Signal" to treat the stored water within the tank. Where hot and cold tanks are close coupled, or there is no ready access to the outlet, the "Air Gap" can be bridged by installing a unit on the supply pipe and grounding one of the aerials to the tank. This procedure is fully explained in the installation instructions.

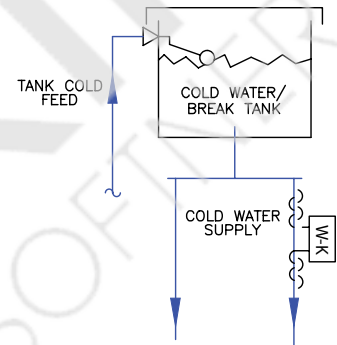

Booster Pumps

Pumps cause a significant reduction in the effectiveness of Water-King so, wherever there is a pump, in general there should be a Water-King unit located downstream from it.

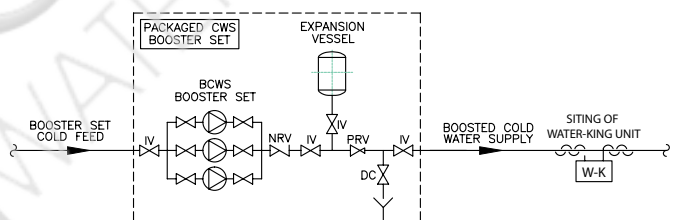

Hot Water Secondary Return (HWSR)

We recommend that the HWSR should be treated with a Water-King unit installed between the circulation pump and the calorifier or water heater.

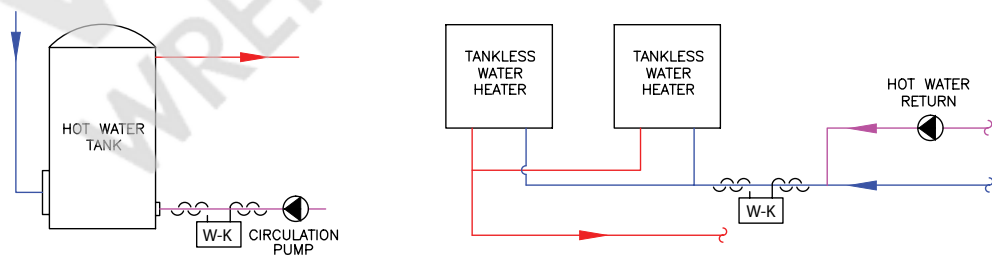

Heat Exchangers and Modular Tank Heaters. (eg Andrews MAXXflo)

We recommend that the flow and the return of heat exchangers are treated. Aerials should be applied to the flow after the pump. This is most easily achieved using one of the four aerial units such as the WK2 or WK3. Frequently however, access is limited or the pump is too closely located to allow treatment of the flow. In these cases we recommend treating only the return. This applies especially to modular tank heaters where the Water-King should be installed on the return lines inside the casing.

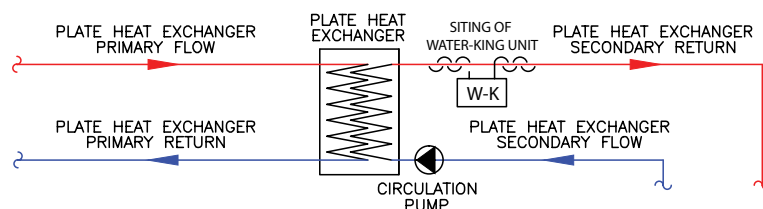

Low Water Content Finned Type Water Heaters

Generally this type of water heater is highly resistant to scaling, but to protect buffer vessels and other downstream appliances we recommend treatment of the return to the buffer at a point after the HWSR and make up water.

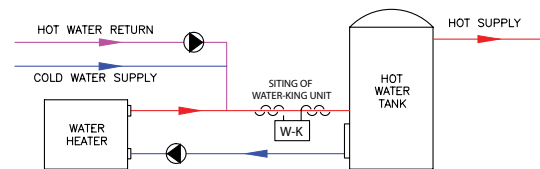

Cold Water Supply to Mixing Valves and Showers

Most of the scale formed in these fittings is precipitated from cold water. The cold water supply to these appliances should also be treated with a Water-King unit. When a conventional water softener is installed to treat only the hot water services it is common to find scale forming in mixing valves, shower heads and taps. A Water-King unit installed on the cold services will reduce this scaling.

Re-Circulating Systems and Swimming Pools

Where water is being constantly circulated, such as through a cooling tower or swimming pool, the Water-King unit should be fitted on the circulating system downstream from the pump and as close as possible to where the heating process or pressure drop is occurring. There is no need to treat the make up water. Adequate provision must be made for filtering to remove suspended solids.

On a swimming pool the unit should be installed between the pump and the filter or heater.

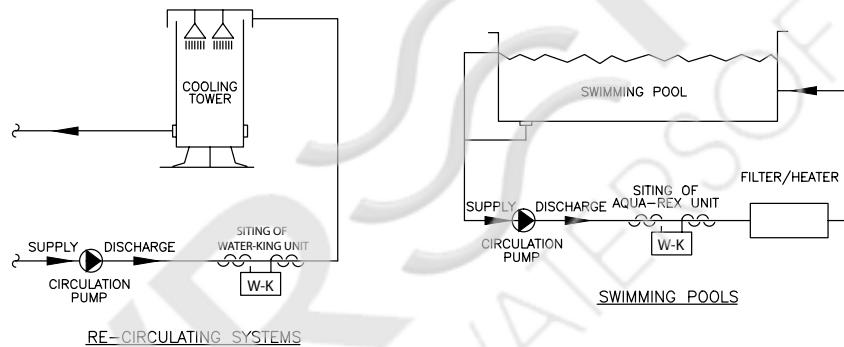

Irrigation Systems and Misters

Install a Water-King unit after the pump. On high pressure mister lines we recommend a Sentry unit is installed on each line.

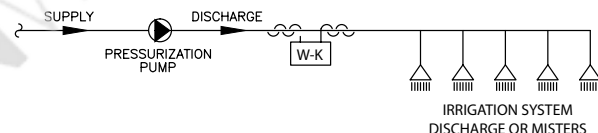

Plumbing Requirements and Pipe Composition

Each Water-King aerial requires up to 6 cm of straight pipe. They can be fitted either side of bends on horizontal or vertical pipes. Water-King units can be fitted to pipes of any material except lead. The pipe does not need to be cut, there is no plumbing involved, nor is there any requirement for an isolating bypass with associated valves. Insulation may be fitted over the aerials after installation.

Power Requirements

Each unit requires mains voltage supply within one metre of the unit. The unit should be located within 45 cm of the pipe being treated.

Evaporative Systems

Where systems are designed to operate with make up water for evaporation, such as cooling towers or humidifiers, adequate provision must be made to clear any deposits by regular "blow down" or other means.

Suggested Specification For Water Treatment

One or more electronic water conditioners shall be fitted to the cold mains supply and HWR in accordance with the manufacturer's recommendations. The unit shall have one or more pairs of open ended aerials wrapped around the pipework generating a series of square waves of random length and occurrence between 1 kHz and 10 kHz. The peak to peak output voltage will be in excess of 80 volts.

Selecting the Correct Size of Unit

Pipe Diameter

Having decided where to locate the Water-King, select the appropriate sized unit according to the pipe diameter. If hot water is provided by a Direct Fired Water Heater then select the larger size according to the maximum output rating.

Direct Fired Water Heaters

We recommend maximum heat ratings for different sized units and this also varies according to whether they are gas fired, oil fired or heated electrically.

Flow Rate

Flow Rate is immaterial as far as Water-King is concerned. The greater the flow, the more effective the unit tends to be.

Selection	SENTRY	WK2	WK3	WK4	WK5
Maximum pipe diameter	28mm	42mm	67mm	108mm	159mm
Direct fired gas / oil boiler	35 kW.	50 kW.	350 kW.	750 kW.	1125 kW.
Electrical boiler	15 kW.	30 kW.	50 kW.	100 kW.	150 kW.
Product Data					
Aerial number/length	2/2.0 m.	4/2.0 m.	4/4.0 m.	4/7.0 m.	6/9.0 m.
Minimum aerial turns	12 turns	12 turns	15 turns	15 turns	15 turns
Frequency range	1-10 kHz.	1-10 kHz.	1-10 kHz.	1-10 kHz.	1-10 kHz.
Peak to peak output voltage	82 V.	82 V.	82 V.	82 V.	82 V.
Power supply required	230 V or 110 V.	230 V or 110 V.	230 V or 110 V.	230 V or 110 V.	230 V or 110 V.
Input current	0.02 A.	0.03 A.	0.04 A.	0.08 A.	0.1 A.
Power consumption	1 W.	1 W.	2 W.	2 W.	3 W.
Lead length	1.5 m.	1.5 m.	1.5 m.	1.5 m.	1.5 m.
Dimensions (mm.)	140 x 85 x 50	220 x 155 x 67	220 x 165 x 60	270 x 260 x 110	270 x 260 x 110
Weight	0.80 kg.	1.25 kg.	1.50 kg.	3.00 kg.	3.25 kg.
Ambient temperature	0 - 70°C	0 - 70°C	0 - 70°C	0 - 70°C	0 - 70°C
Humidity non-condensing	Waterproof	80%	80%	80%	80%
IP Rating	IP 68		IP 65	IP 65	IP 65
BMS output	No	No	Yes	Yes	Yes

Self-Diagnostic "Guard Chip"

Every computer system is prone to malfunction, especially if there is a sudden variation in the power supply which can jam the program. Most systems have to be reset by manual re-booting. Water-King units overcome this problem by an additional "Guard Chip" program which monitors the performance of the main program and resets the system automatically if it detects a variation or system failure. There is no need for manual resetting after power outage.

Product Features

WATER-KING SENTRY The Water-King Sentry is the entry level unit and has been specifically designed with the needs of the Housing Associations and RSL's in mind. It is compact, tamper resistant, and automatically resets so requires no monitoring.

It is fully waterproof (IPX8 3 meters) so can be used in damp or hostile environments, including commercial catering applications, shower blocks and external use on irrigation systems. It is especially suitable for protecting individual appliances.

WATER-KING WK2 The Water-King WK2 is larger and more powerful than the Sentry. It has two pairs of aerials which can be used to reinforce the signal to a single pipe, or split to treat a second pipe. This arrangement ideally suits the designs of many heat exchangers.

WATER-KING WK3 The Water-King WK3 is a powerful unit designed to treat most commercial applications. It is frequently specified to treat the mains cold water supply to direct fired water heaters and paired with a Sentry on the secondary return. The WK3 and larger units have an output for a Building Management System (BMS) to detect power failure.

WATER-KING WK4 The Water-King WK4 is designed to treat large commercial applications, with pipe sizes up to 108mm. The WK4 is frequently specified in high rise developments, large student accommodation blocks and hotels.

WATER-KING WK5 The Water-King WK5 is the largest standard Water-King. It has six aerial outputs arranged as three pairs, which are capable of treating pipe sizes up to 159mm. Larger units are available as a special order.

Technical Assistance for specifications

Our technical department is very experienced at advising consultants and contractors of the most effective way of treating water using Water-King technology. We are able to receive drawings by e-mail and will respond immediately.